

SHALLCO SERIES 26
Part Number: 2622D
POWER FACTOR SWITCH



Electrical:

- 25/A125VAC\
- 15A/600 VAC
- 20A/600 VAC (RES)
- 3A/125 VDC
- 1A/250 VDC



- * Dielectric Withstanding Voltage: 2200 Vrms
- * Contact Resistance: Initial, 10 milliohms max.
- * Insulation Resistance: 100 Megohms min., initial

Mechanical:

- * Sections: 1
- * Positions: 2 (Break before Make)
- * Indexing: 45° positive detent
- * Rotational Life: 65,000 operations

Materials and Finishes:

- * Rotors and Stators: Thermoset Plastic, UL 94VO
- * Rotor contacts: Phosphor bronze
- * Stator contacts: Silver plated copper, screw type
- * Terminal hardware: silver plated brass
- * Exterior Metal: Steel with zinc chromate finish
- * Knob: thermoset phenolic

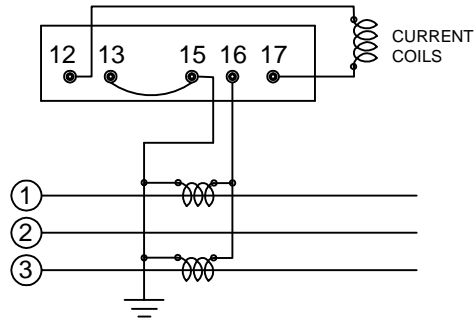

DECK	CONTACTS	POS.	
		OFF	ON
1	12-O-13		X
	16-O-15 16-O-17	X	X

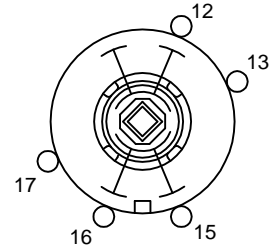

CONTACT TABLE

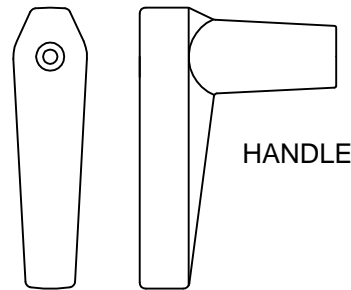

HANDLE

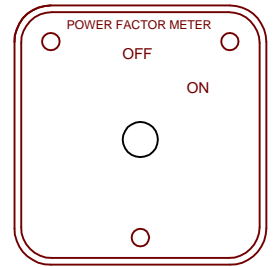

NAMEPLATE

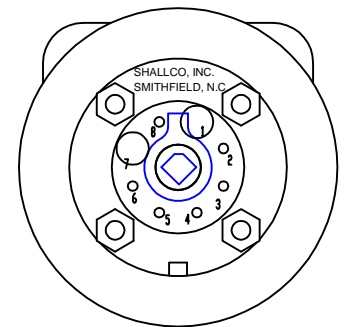
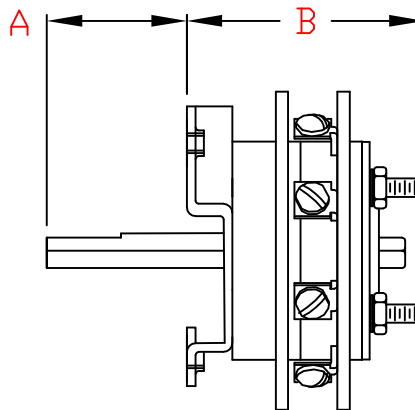
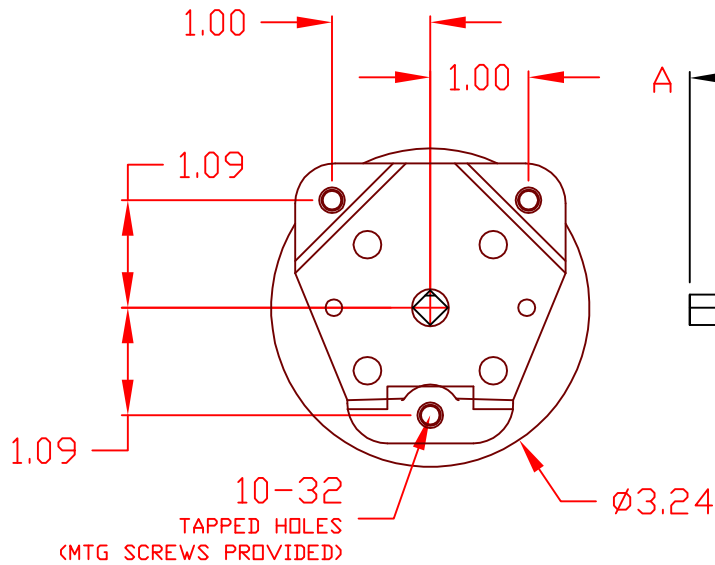

2622D

REV.-

HANDLE TYPE: D (PISTOL GRIP)

"A" DIM: 1.61

"B" DIM: 2.41



308 COMPONENTS DRIVE
 SMITHFIELD, NC 27577 USA